

X2-RA(X2-R19A) Series

Rocker Switches



SPECIFICATION

Electrical Rating : 2A 125V AC/250V AC(UL,VDE)
6A 250V AC(standard)(UL,VDE)
15A 125V AC & 8A 250V AC(UL)

Mechanical life: Over 30000 cycles

Electrical life: Over 10000 cycles

Contact resistance: <20mΩ

Insulation resistance: >1000MΩ

High voltage resistance: >1500VAC 1 min.

Ambient temperature: Terminal side -20 to +85°C

Actuating side- 20 to +55°C

Atmospheric humidity: Max.85%

Actuating force: 3 to 6N(depends on different switch function)

Flammability: UL94V-2 & UL94V-0

Storage temperature: -30 to +80°C Max

Temperature rise at the terminal: Max 30°C (UL1054)

Solder ability of terminal: Max 350°C 3s

MATERIALS

Housing: PA 66

Rocker: PA 66 & PC

Contacts: Silver alloy

Terminal: Copper or brass silver plated,phosphorus bronze

Spring: SWC

Movable arm: Copper silver plated

Lamp: LED

Bracket: PA66



HOW TO ORDER

X2-RA 1 2 K K F T O F P

Series

Switch Function

Rating

Housing Color

Actuator Color

Marking

Terminal

Lamp Color

Safe Approval

Actuator Type

Series

1	ON-OFF
2	ON-ON
3	ON-OFF-ON
4	ON-(ON)
5	OFF-(ON)
6	(ON)-OFF-(ON)
7	ON-(OFF)
8	ON-OFF-(ON)
9	ON-OFF(WITH LED)

2	6A 250V AC
5	8A 250V AC 15A 125V AC

G	Gray
W	White
K	Black

G	Gray
W	White
K	Black
R	Red

See option of marking
(See Page 231)

See terminal type

R	Red LED
Y	Yellow LED
M	Green LED
O	Without LED

F	4 Safety Approvals
B	UL CUL

P	Paddle Switch
	Rocker Switch
C	Switch Round

OPTIONS OF SWITCH FUNCTION / DIMENSION

Item No	POLES & THROWS	Rocker position ():Momentary		
		Left	Center	Right
X2-RA1	SPST	ON	None	OFF
X2-RA2	SPDT	ON	None	ON
X2-RA3	SPDT	ON	OFF	ON
X2-RA4	SPDT	ON	None	(ON)
X2-RA5	SPST	OFF	None	(ON)
X2-RA6	SPDT	(ON)	OFF	(ON)
X2-RA7	SPST	ON	None	(OFF)
X2-RA8	SPDT	ON	OFF	(ON)
X2-RA9	SPST (With LED)	ON	None	OFF

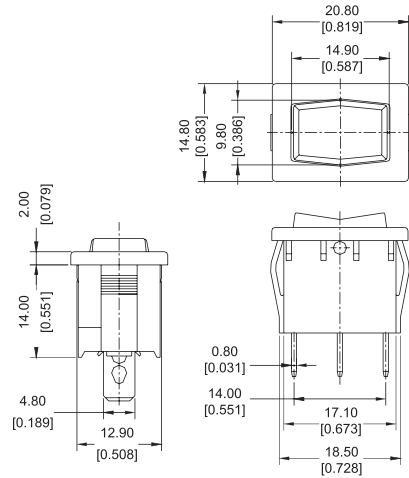

PANEL CUT OUT

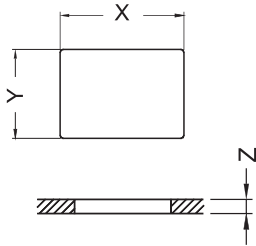

Z	Y	X
0.7~1.25	12.8~12.9	19.2~19.3
1.25~2.0	12.8~12.9	19.3~19.4
2.0~3.0	12.8~12.9	19.5~19.6

CIRCUITS FOR SWITCH WITH LAMP

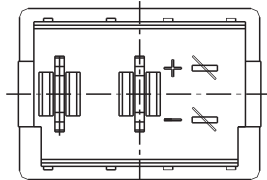

CIRCUIT FOR LOAD

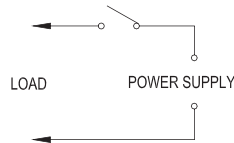

CIRCUIT FOR LED

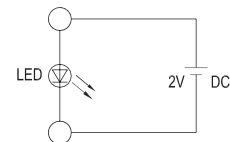

TERMINAL TYPE

T&H

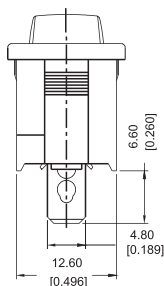

S

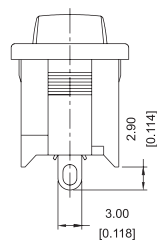

W

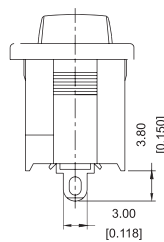

R

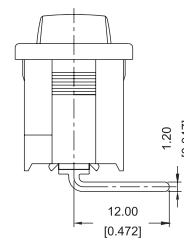

P

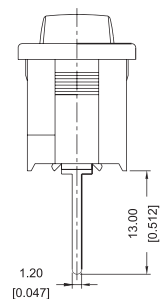

T(Quick connect tab:Thickness of 0.8mm)
H(Quick connect tab:Thickness of 0.5mm)